

TYPE: _____

JOB: _____

SPECIFICATIONS

HOUSING - Heavy gauge extruded aluminum (material of corrosion resistant alloy.) Heavy gauge CRS end plates.

ELECTRICAL - PAR, 120v.

SOCKET - PAR, medium base, porcelain, 500w, 250v.

MOUNTING - Recessed, plaster ceiling.

LABELS - UL, C-UL -Damp Location.

LAMP - PAR 30, 120v - by others.

FINISH - Powder paint on all surfaces. RAL colors standard, consult factory for custom finishes.

APPLICATIONS

Recessed square aperture, trimless accent light. Perfect for retail, residential, or commercial applications.

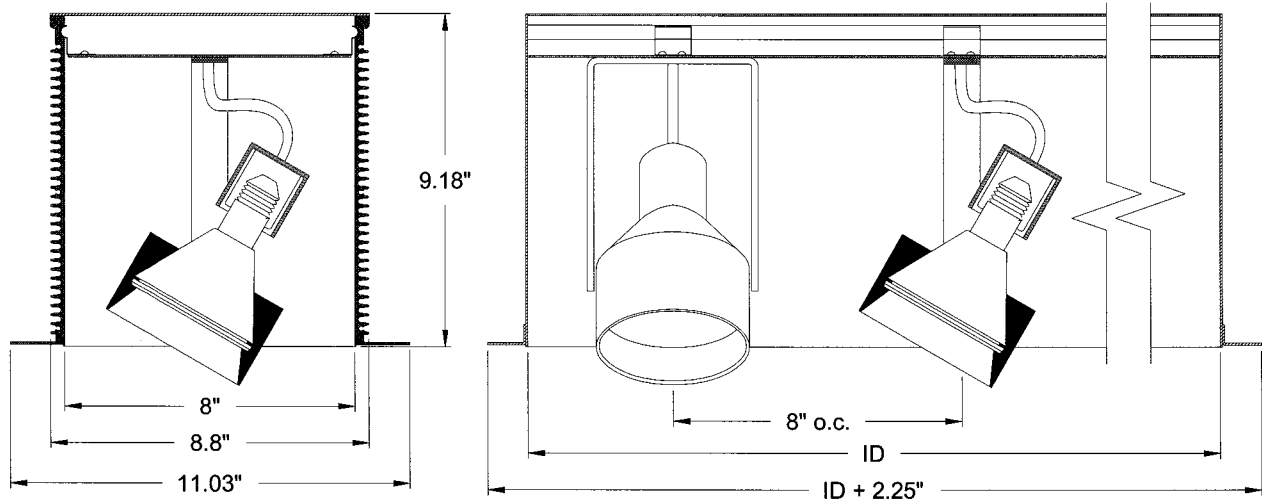

ORDERING INFORMATION

FIXTURE	NUMBER OF LAMPS	FINISH
#1005S PAR30		
Recessed display lighting system	2L16 = 2 lamps, 16" ID 3L24 = 3 lamps, 24" ID 4L32 = 4 lamps, 32" ID 5L40 = 5 lamps, 40" ID 6L48 = 6 lamps, 48" ID	WHT = White BLK = Black XXXX = RAL # CST = Custom (must supply chip)



SPECIALTY LIGHTING INDUSTRIES, INC. ©2004

1306 DORIS AVENUE OCEAN, NJ 07712 800.462.7812 732.517.0800 FAX 732.517.0971 www.specialtylightingindustries.com

These specifications subject to change without notice.